



# Einhell



**PUMPING MADE EASY.**  
WATER TECHNOLOGY FOR  
HOUSE AND GARDEN.

[einhell.de](https://www.einhell.de)

>>>



# WATER TECHNOLOGY

<b>All you need to know about pumps</b>	<b>3</b>
Pump Advisor	3
Drainage – Watering – Domestic Water Supply	4
The right Pump for the right Purpose	6
Pump Technology – Main Facts	8
<b>Power X-Change Cordless Pumps</b>	<b>10</b>
Cordless Submersible Pressure Pump/ Rain Barrel Pump	13
Cordless Clear Water Pumps	14
Cordless Dirty Water Pumps	15
Cordless Automatic Garden Pump	17
Cordless Garden Pumps	18
<b>Drainage – Submersible Pumps</b>	<b>20</b>
Submersible Pumps at a Glance	20
Aqua Sensor Dirty Water Pumps	23
Aqua Sensor Clear Water Pump	23
2-in-1 Multipurpose Pumps	24
For Environmental's Sake – pump right.	27
Submersible Pumps Dirty/Clear Water ECO	28
Dirty Water Pumps	29
Rain Barrel Pump	32
Clear Water Pumps	33
Submersible Pressure Pumps	34
Deep Well Pumps	35

<b>Watering – Surface Pumps</b>	<b>36</b>
Surface Pumps at a Glance	36
Surface Pumps PLUS	38
Garden Pumps PLUS	40
Garden Pumps	42
<b>Domestic Water Supplies</b>	<b>44</b>
Automatic Home and Garden Pumps SMART	44
Automatic Home and Garden Pumps PLUS	46
Automatic Home and Garden Pumps	47
Water Works PLUS	48
Water Works	50
Petrol Water Pumps	52
<b>Accessories</b>	<b>53</b>
Surface Pumps Accessories	53
Which accessories go with which surface pump?	55
<b>Service</b>	<b>56</b>

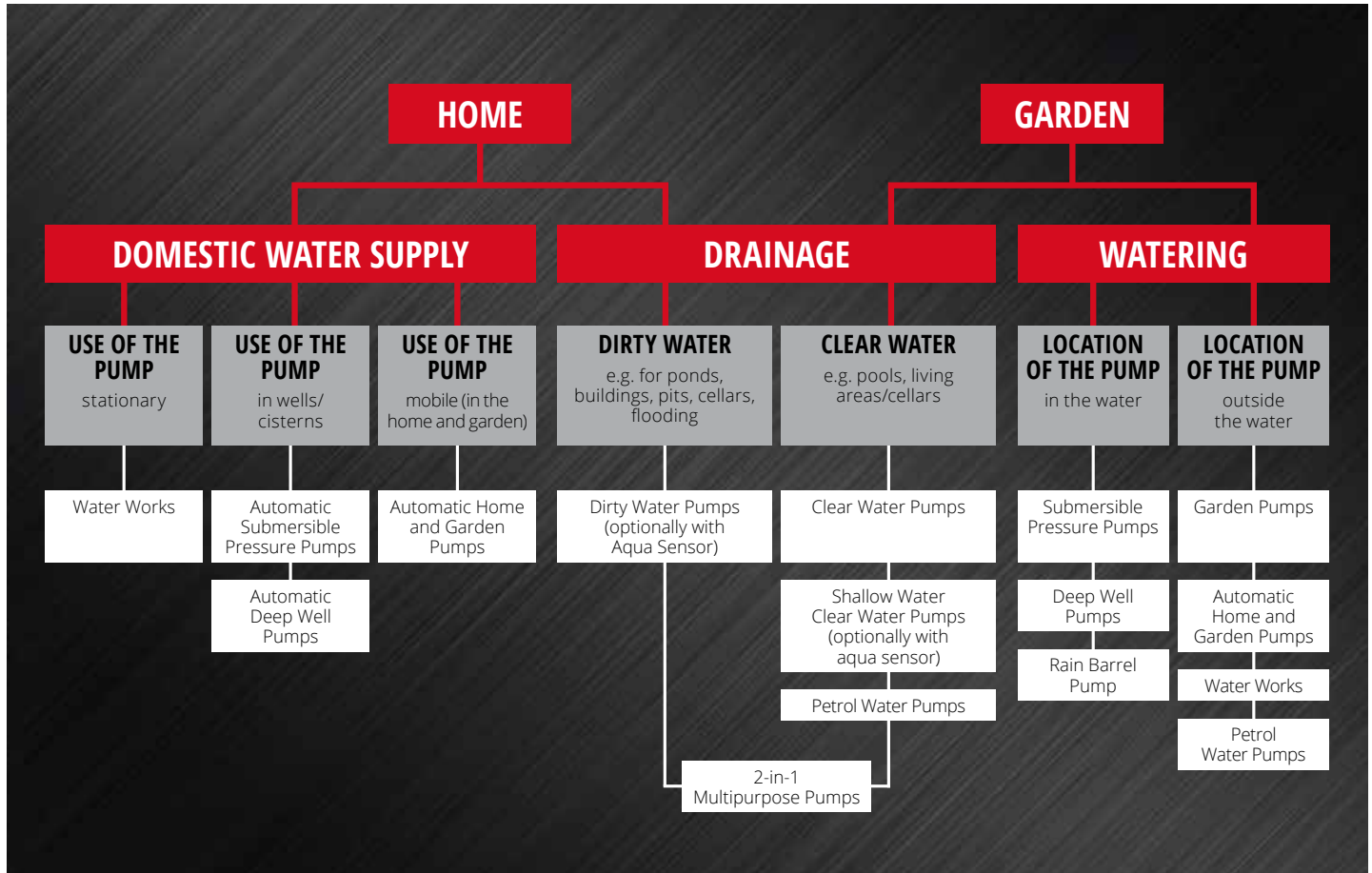



Powerful



Economical



Environmentally friendly



Versatile



## DRAINAGE

Repumping/pumping out water – quicker and easier than ever. Pumping both clear water and dirty water with a high delivery rate is no problem with Einhell drainage pumps.

- Delivery of large quantities of water quickly
- Prevention of the worst water damage as far as possible by pumping out quickly
- High level of operational safety and reliability



## WATERING

To avoid wasting precious drinking water on watering the garden, alternative sources of water such as rainwater or water from cisterns can be used instead.

- Uniform garden watering
- User-friendly and safe handling
- Conserves resources and saves drinking water



## DOMESTIC WATER SUPPLY

Fully automatic and with constant pressure. With the domestic water pumps or automatic submersible pressure pumps from Einhell, you can put collected rainwater to use in the home, for example for toilet flushing, in your washing machine or for outdoor uses.

- Water supply for home and garden from alternative water reservoirs (cisterns, wells)
- User-friendly and safe handling
- Conserves resources and saves drinking water



**DRAINAGE**



**WATERING**



**DOMESTIC WATER SUPPLY**

# THE RIGHT PUMP FOR THE RIGHT PURPOSE.

Whether in the home or in the garden – Einhell has the right pump for every application:

## 1 | DEEP WELL PUMP

for watering the garden

» Read more on p. 35

## 2 | RAIN BARREL PUMP

for easy drawing of water from rainwater reservoirs

» Read more on p. 13 and p. 32

## 3 | MULTIPURPOSE PUMP / CLEAR WATER PUMP

for emptying pools

» Read more on pp. 13 - 14, pp. 24 - 25 and p. 33

## 4 | POWER X-CHANGE CORDLESS GARDEN PUMP

for cordless garden watering

» Read more on pp. 17 - 19

## 5 | SUBMERSIBLE PRESSURE PUMP

for watering the garden

» Read more on p. 34

## 6 | PETROLWATER PUMPS

for watering the garden independently of the mains supply

» Read more on p. 52

## 7 | MULTIPURPOSE PUMP / DIRTY WATER PUMP

for draining ponds

» Read more on pp. 15, p. 24 - 25 and pp. 28 - 31

## 8 | GARDEN PUMP

for watering gardens from cisterns

» Read more on pp. 17 - 19 and pp. 40 - 43

## 9 | AQUA SENSOR PUMP

for round-the-clock protection against flooding

» Read more on pp. 22 - 23

## 10 | AUTOMATIC HOME AND GARDEN PUMPS / WATER WORKS

for automatic domestic water supplies with service water

» Read more on pp. 44 - 51

NOW ALSO  
AVAILABLE AS A  
**CORD-  
LESS**  
VERSION  
SEE P. 13

NOW ALSO  
AVAILABLE AS A  
**CORD-  
LESS**  
VERSION  
SEE PP. 13/14

NOW ALSO  
AVAILABLE AS A  
**CORD-  
LESS**  
VERSION  
SEE P. 15

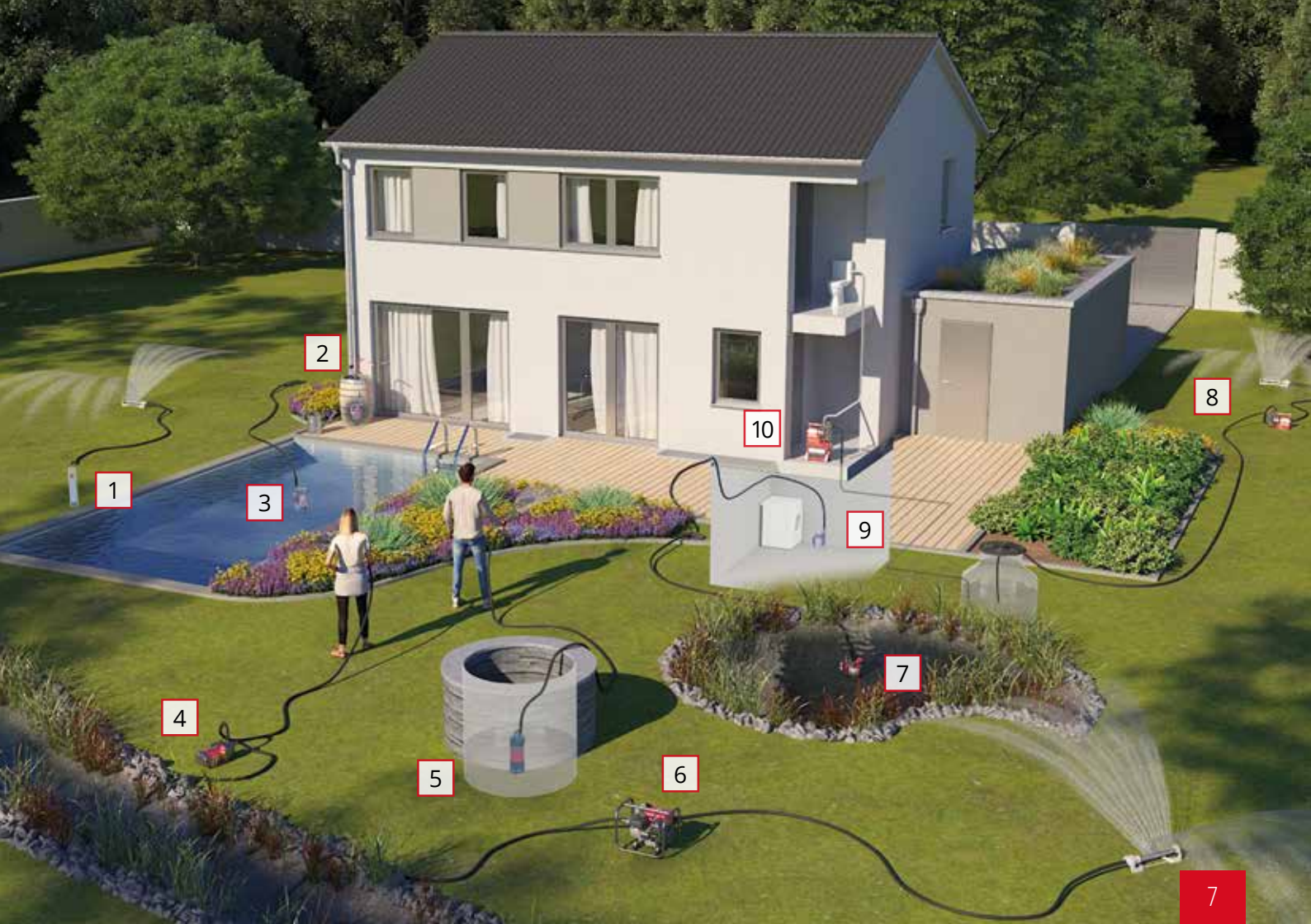

1

2

3

10

9

8

4

5

6

7

7

## GENERAL TERMS. SURFACE PUMPS.

- 1 Suction Height**  
Height difference the pump and the surface of the water (max. 8 m).
- 2 Delivery Head**  
Height difference between the pump (pressure connection) and the outlet of the water from the connected device.
- 3 Service water**  
Service water is pumped by means of a pump from a well, shaft or cistern. It is not potable and must not be used for drinking water or for the preparation of food. In private households, service water can be used in separate outlets away from the drinking water supply as a supply for toilet flushing systems or washing machines.

 **Delivery Pressure = Delivery Head**  
30 m delivery head = 3.0 bar

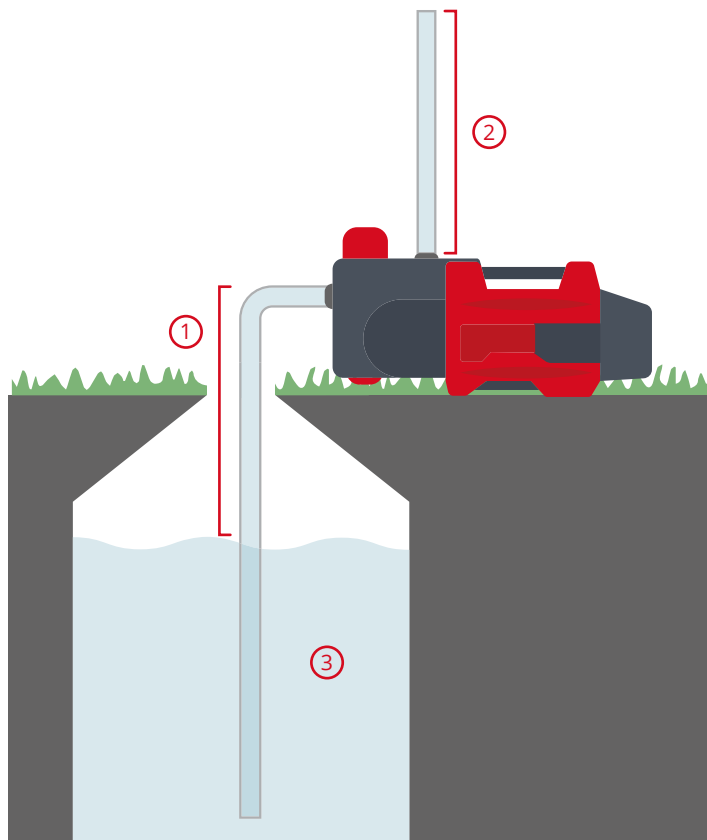



## GENERAL TERMS. SUBMERSIBLE PUMPS.

- 1 Delivery Head**  
Height difference between the surface of the water and the outlet of the water from the connected device.
  - 2 Immersion Depth**  
Height difference between the surface of the water and the pump.
  - 3 Clear Water**  
Water containing foreign particles of up to 5 mm in size is generally referred to as clear water. The Einhell range of submersible motor pumps offers numerous options for pumping out and repumping clear water.
  - 4 Dirt Water**  
Water containing foreign particles of up to 40 mm in size is generally referred to as dirty water. Here too Einhell has a diverse range of dirty water pumps.
-  **Delivery Pressure = Delivery Head**  
10 m delivery head = 1.0 bar

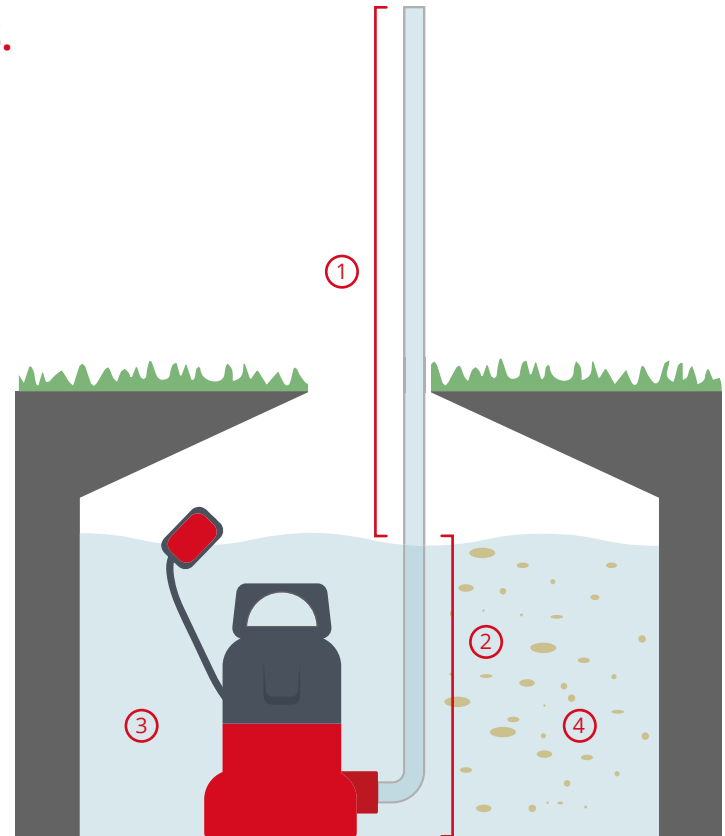

**CORDLESS EXCELLENCE.**

**CONVINCING. AGAIN AND AGAIN.**

**POWER X-CHANGE**



## **EINHELL. CORDLESS EXCELLENCE.**

It became clear to us early on that our customers wanted the freedom of cordless operation. We decided accordingly to concentrate fully on the sector of cordless technology and on the expansion of our Power X-Change system of rechargeable batteries. In numerous product tests carried out by prestigious trade journals and independent experts we have been rewarded with "top marks" and the position of "best in the test", confirming

the outstanding quality of our products and underlining Einhell's bundled competence. It is our aim to inspire our customers with Einhell cordless power and to provide them with freedom, fun and enjoyment on all their jobs around the house and garden. This will make Power X-Change a synonym for cordless freedom.



## CORDLESS FREEDOM. FOR TOOL AND GARDEN.

**At last – no more too short or severed cables.**

When you have no longer to worry about extension cables that are too short or sufficient sockets. When the device comes to the project instead of the other way round. When you simply insert the battery and are ready to go, whether it is a lawn mower, garden pump, rotary hammer or wet and dry vacuum cleaner. Than that is the feeling of cordless freedom.



## LATEST TECHNOLOGY. PROVEN QUALITY.

**For the highest level of safety and performance.**

Power X-Change batteries are the core component of our platform. That's why we use only the best components such as highperformance new-generation cells and our intelligent processorcontrolled battery electronics. This makes our PXC battery one of the safest in the industry and ensures efficiency, reliability and durability.



## POWERFUL MACHINES. LONG-LASTING BATTERIES.

**No matter how large your project – Power X-Change won't let you down.**

Less power? No way! As a battery system for real enablers, our cordless machines offer up to 2700 Watt of battery power and 8 Ah of capacity, making them easily a match for corded machines! Whether you just want to hang a shelf or drill through a solid concrete wall, with Power X-Change you are equipped to meet any challenge with power and endurance.



## 1 BATTERY. 1000 POSSIBILITIES. FOR DIY ENTHUSIASTS AND HOBBY GARDENERS.

**Just as versatile as you: Battery power for every situation.**

Power X-Change is the first rechargeable battery system that provides hobby gardeners and DIY enthusiasts alike with an unrivaled selection of cordless tools. The PXC family already contains over 250 devices. To enable us to offer you cordless freedom in even more areas of life, we have opened our platform to strong partners. Thanks to the versatile Power X-Change system diverse items from partner companies are "Powered by Power X-Change"

**1 BATTERY. NOW ALSO FOR WATER TECHNOLOGY.**  
**ONLY FROM EINHELL.**



THE EXPERTS IN THE FIELD OF **CORDLESS WATER TECHNOLOGY.**



**+** **CORDLESS**  
for use independently of a  
mains power supply even  
in an emergency

**+** **POWERFUL**  
thanks to state-of-the-art  
battery technology

**+** **FLEXIBLE**  
maximum freedom of  
movement in the garden

## CORDLESS FREEDOM. WITH CORDLESS PUMPS.

These cordless clear water pumps are high-performance members of the Power X-Change family. They convey water independently of the mains supply, are flexible in use and powerful in operation.

Thanks to its high delivery pressure, the 2-in-1 pump GE-PP 18 RB Li can be used as a submersible pressure pump, e.g. in a cistern, but also as a rainwater barrel pump when combined with the adjustable connecting pipe.

With its lower pressure but higher delivery rate the cordless clear water pump GE-SP 18 Li is ideal for pumping out and repumping water wherever it needs to be conveyed independently of a mains power supply.



## CORDLESS SUBMERSIBLE PRESSURE / RAIN BARREL PUMP

**2-IN-1**  
SUBMERSIBLE  
PRESSURE PUMP  
+  
RAIN BARREL  
PUMP

EXTENSION



	<b>GE-PP 18 RB Li - Solo</b> <b>EXPERT</b>
PXC battery voltage / capacity	18 V -
Max. delivery capacity / height	3000 l/h / 20 m
Max. immersion depth	4 m
Hose connection	33.3 mm (1") ET
Power cord	5 m
Product weight excl. / incl. accessories	2.5 / 2.8 kg
Mobile battery box	•
Integrated cable rewind	•
Integrated wall mount	•
Suspension device made from stainless steel	•
Telescopic extension tube	•
Flexible gooseneck	•
Number of batteries / number of chargers	0 / 0
Article number	41.704.29



## CORDLESS CLEAR WATER PUMPS



	<b>GE-SP 18 LL Li - Solo</b> <b>EXPERT</b>	<b>GE-SP 18 Li - Solo</b> <b>EXPERT</b>
PXC battery voltage / capacity	18 V / -	18 V / -
Max. delivery capacity / height	4500 l/h / 8 m	5000 l/h / 8 m
Max. immersion depth	4 m	4 m
Suction down to	low level suction down to 1 mm	15 mm
Hose connection	33.3 mm (1") ET	33.3 mm (1") ET
Power cord	5 m	5 m
Product weight excl. / incl. accessories	2.2 / 2.3 kg	2.6 / 2.7 kg
Mobile battery box	•	•
Dry running protection	•	•
Integrated cable rewind	•	•
Integrated wall mount	•	•
Suspension device made from stainless steel	•	•
Telescopic extension tube	-	-
Flexible gooseneck	-	-
Number of batteries / number of chargers	0 / 0	0 / 0
Article number	41.815.60	41.815.00

## CORDLESS DIRTY WATER PUMPS



	<b>GE-DP 18/25 Li - Solo</b> <b>EXPERT</b> <b>NEW</b>	<b>GE-DP 18/25 LL Li - Solo</b> <b>EXPERT</b> <b>NEW</b>
PXC battery voltage / capacity	18 V / -	18 V / -
Max. delivery capacity / height	7500 l/h / 5 m	7000 l/h / 5 m
Max. immersion depth	4 m	4 m
Suction down to	35 mm	1 mm
Max. size of foreign particle	25 mm	25 mm
Hose connection	42 mm (1¼") ET	42 mm (1¼") ET
Power cord	5 m	5 m
Product weight excl. / incl. accessories	3.3 / 3.4 kg	3.4 / 3.5 kg
Mobile battery box	•	•
Dry running protection	•	•
Integrated cable rewind	•	•
Integrated wall mount	•	•
Suspension device made from stainless steel	•	•
Low level suction down to 1 mm	-	•
Power level switch: ECO and BOOST mode	•	•
Suction level control	-	•
Number of batteries / number of chargers	0 / 0	0 / 0
Universal hose adapter	•	•
Article number	41.815.80	41.815.90







## CORDLESS AUTOMATIC GARDEN PUMP

The automatic cordless garden pump is a high-performance pump of the flexibly interchangeable Power X-Change series for cordless use. The 36 V twin-pack technology combines the power of two 18 V rechargeable batteries for maximum performance. To save battery running time, an integrated pressure switch activates the pump when water is needed and deactivates it when the water flow has stopped. Featuring both ECO mode and BOOST mode it can be adapted to the actual application. Dry running protection, a pre-filter with dirt indicator and a water level indicator ensure optimum operation while simultaneously protecting the pump against dirt accumulation.

## CORDLESS AUTOMATIC GARDEN PUMP

### AQUINNA



**AQUINNA 36/38 F LED AUTOMATIC**  
**EXPERT** **NEW**

PXC battery voltage / capacity	2x 18 V / -
Max. delivery capacity / height	3800 l/h / 37 m
Max. suction height	6 m
Suction connection	33.3 mm (1") ET
Pressure connection	33.3 mm (1") IT
Product weight	4.8 kg
Water filler screw	•
Water drain screw	-
Power level switch: ECO and BOOST mode	•
Battery capacity indicator LED	•
Pre-filter	•
Non-return valve	•
Water filling / dirt indicator	• / •
Suction indicator	•
Automatic mode	•
Dry running protection	•
Number of batteries / number of chargers	0 / 0
Accessories	-
Article number	41.804.20



## CORDLESS GARDEN PUMPS

### AQUINNA



	<b>AQUINNA 36/38 F LED</b> <b>EXPERT</b> <span style="float: right;"><b>NEW</b></span>	<b>AQUINNA 36/30</b> <b>EXPERT</b>
PXC battery voltage / capacity	2x 18 V / -	2x 18 V / -
Max. delivery capacity / height	3800 l/h / 37 m	3000 l/h / 26 m
Max. suction height	6 m	8 m
Suction connection	33.3 mm (1") ET	42 mm (1¼") ET
Pressure connection	33.3 mm (1") IT	33.3 mm (1") IT
Product weight	4.3 kg	3.3 kg
Water filler screw	•	•
Water drain screw	•	•
Power level switch: ECO and BOOST mode	•	•
Battery capacity indicator LED	•	-
Pre-filter	•	-
Non-return valve	•	-
Water filling / dirt indicator	• / •	- / -
Suction indicator	-	-
Automatic mode	-	-
Dry running protection	-	-
Number of batteries / number of chargers	0 / 0	0 / 0
Accessories	-	Adapter 33.3 mm (1") ET
Article number	41.804.10	41.804.00

## CORDLESS GARDEN PUMPS

### AQUINNA



	<b>AQUINNA 18/30 F LED</b> <b>EXPERT</b> <span style="float: right;"><b>NEW</b></span>	<b>AQUINNA 18/28</b> <b>EXPERT</b> <span style="float: right;"><b>NEW</b></span>
PXC battery voltage / capacity	18 V (+ 18 V) / -	18 V / -
Max. delivery capacity / height	3000 l/h / 28 m	2800 l/h / 25 m
Max. suction height	6 m	6 m
Suction connection	33.3 mm (1") ET	33.3 mm (1") ET
Pressure connection	33.3 mm (1") IT	33.3 mm (1") IT
Product weight	3.9 kg	2.4 kg
Water filler screw	•	•
Water drain screw	•	•
Power level switch: ECO and BOOST mode	•	•
Battery capacity indicator LED	•	-
Pre-filter	•	-
Non-return valve	•	-
Water filling / dirt indicator	• / •	- / -
Suction indicator	-	-
Automatic mode	-	-
Dry running protection	-	-
Number of batteries / number of chargers	0 / 0	0 / 0
Article number	41.804.30	41.804.40



## SUBMERSIBLE PUMPS AT A GLANCE.

Whether for pumping out a flooded cellar or a construction pit, or for emptying pools or ponds – submersible pumps are the perfect aid. The main task of a submersible pump is to pump as much water as possible within the shortest possible time. The parameter that describes this ability is known as the delivery rate and is measured in liters/h.

Submersible pumps can be divided into two categories: depending on the area of application and how clean or dirty the water is that is to be pumped, you can choose either a clear water pump or a dirty water pump. But our range of submersible pumps also includes multitalents such as the 2-in-1 combination pumps for clear water and dirty water.

For more challenging tasks, such as pumping water from greater depths or under particularly high pressure, our deep well and submersible pressure pumps do a really fine job.



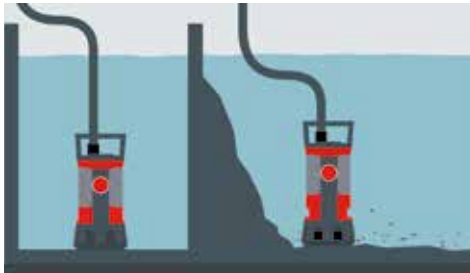

1

### AQUA SENSOR PUMPS

Pump clear water or dirty water at any time thanks to the automatic sensor start function.



2

### DIRTY WATER PUMPS

Quickly pump out dirty water from ponds, construction pits or cellars.

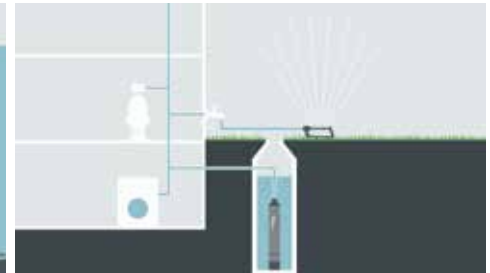

3

### DEEP WELL PUMPS

For pumping water from particularly large depths for house and garden.

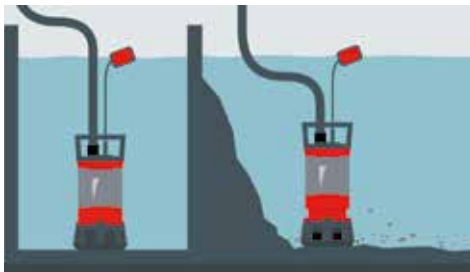

4

### 2-IN-1 MULTIPURPOSE PUMPS

Pump clean water and dirty water with the aid of the suction level adjustment.



5

### CLEAR WATER PUMPS

Quickly pump out clean water from pools, living areas or cellars.

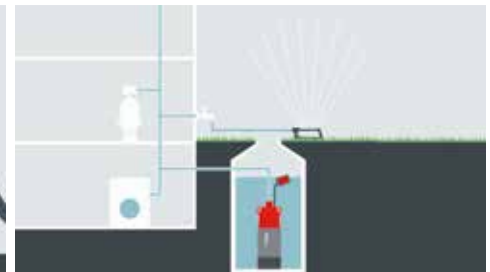

6

### SUBMERSIBLE PRESSURE PUMPS

For pumping water to particularly great heights or under very high pressure for house and garden.

## 24/7 PROTECTION FROM FLOODS.

Thanks to our Aqua Sensor Technology, the pumps operate with patented sensor adjustment at three automatic starting heights or can be used in continuous operation. Thanks to the integrated aqua sensor, the pumps offer a slim-line design and can be used in narrow shafts.

Increased safety for your home so you can enjoy your holiday without worries: The aqua sensor continuously monitors its environment and, depending on the model, sucks up the water until the surroundings can be wiped dry. This puts an end to unplanned and expensive surprises and provides you with immediate, round-the-clock protection – 24 hours a day, even when you are away.



Clearly arranged adjustment of the three automatic sensor starting heights or the permanent mode.

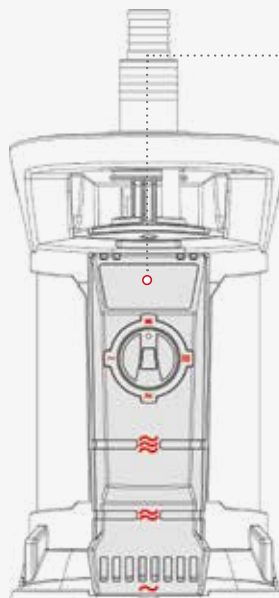

	<b>AQUA</b> SENSOR CLEAR WATER	<b>AQUA</b> SENSOR DIRTY WATER
Permanent mode (ON/OFF) without using the sensor – pump start	5 mm	50 mm
Automatic sensor start at	103 mm	188 mm
Automatic sensor start at	56 mm	135 mm
Automatic sensor start at	5 mm	70 mm

## 'AQUA SENSOR' DIRTY WATER PUMPS

**AQUA SENSOR**  
DIRTY WATER



	<b>GE-DP 7935 N-A ECO</b> <b>EXPERT</b>	<b>GE-DP 6935 A ECO</b> <b>EXPERT</b>
Mains voltage	230 V ~ 50 Hz	230 V ~ 50 Hz
Rated input	790 W	690 W
Max. delivery capacity / height	19000 l/h / 9 m	17500 l/h / 9 m
Max. immersion depth	7 m	7 m
Max. size of foreign particle	35 mm	35 mm
Pump start during continuous operation	50 mm	50 mm
Sensor starting heights	70 / 135 / 188 mm	70 / 135 / 188 mm
Suction down to	40 mm	40 mm
Hose connection	47.8 mm (1½") ET	47.8 mm (1½") ET
Power cord	10 m	10 m
Product weight	6.2 kg	5.7 kg
Aqua Sensor Technology	•	•
Permanent mode without sensor start	•	•
Non-return valve	•	•
High-quality mechanical seal	•	•
Integrated cable rewind	•	•
Carry handle	•	•
Lifting eye	•	•
ECO Power	•	•
Universal hose adapter	•	•
Article number	41.714.60	41.714.50

## 'AQUA SENSOR' CLEAR WATER PUMP

**AQUA SENSOR**  
CLEAR WATER



	<b>GE-SP 4390 N-A LL ECO</b> <b>EXPERT</b>
Mains voltage	230 V ~ 50 Hz
Rated input	430 W
Max. delivery capacity / height	9000 l/h / 8 m
Max. immersion depth	7 m
Max. size of foreign particle	1 mm
Pump start during continuous operation	5 mm
Sensor starting heights	5 / 56 / 103 mm
Works in shallow clean water as low as	1 mm
Hose connection	47.8 mm (1½") ET
Power cord	10 m
Product weight	4.9 kg
Aqua Sensor Technology	•
Permanent mode without sensor start	•
Non-return valve	•
High-quality mechanical seal	•
Integrated cable rewind	-
Carry handle	•
Lifting eye	•
ECO Power	•
Universal hose adapter	•
Article number	41.714.40

## OUR ALL-ROUNDERS

The 2-in-1 Multipurpose Pumps from Einhell are robust, powerful and reliable aids for pumping out ponds, construction pits and flooded cellars quickly and energy-efficiently, as well as for many other drainage tasks.

Two genuine all-rounders: With the patented suction level adjustment, a simple rotary motion on the foot of the pump allows the unit to be quickly adapted to the required function (clean water mode or dirty water mode) – providing users with a combination pump for two different tasks: for shallow-water applications down to a residual water layer depth of 1 mm in clean water mode (meaning, for example, that a cellar can then simply be wiped dry) or for sucking up dirty water containing dirt particles with a size of up to 30 mm.





## 2-IN-1 MULTI-PURPOSE PUMPS



	<b>GE-DP 7330 LL ECO</b> <b>EXPERT</b>	<b>GE-DP 5220 LL ECO</b> <b>EXPERT</b>	<b>GC-DP 7035 LL</b> <b>CLASSIC</b>
Mains voltage	230 V ~ 50 Hz	230 V ~ 50 Hz	230 V ~ 50 Hz
Rated input	730 W	520 W	700 W
Max. delivery capacity / height	16500 l/h / 8.5 m	13500 l/h / 7.5 m	16000 l/h / 8 m
Max. immersion depth	7 m	7 m	7 m
Max. size of foreign particle	30 mm	20 mm	35 mm
Works in shallow clean water as low as	1 mm	1 mm	1 mm
Starting of pump from water level of	10 mm	10 mm	10 mm
Hose connection	47.8 mm (1½") ET	47.8 mm (1½") ET	47.8 mm (1½") ET
Power cord	10 m	10 m	10 m
Product weight	6.2 kg	5.4 kg	4.5 kg
Patented suction level control	•	•	•
High-quality mechanical seal	•	•	•
Floating switch	Automatic + manual mode	Automatic + manual mode	Automatic + manual mode
Integrated cable rewind	•	•	•
ECO Power	•	•	-
Carry handle with integrated lifting eye	•	•	•
Universal hose adapter	•	•	•
Article number	41.707.90	41.707.80	41.815.70



## FOR ENVIRONMENTAL'S SAKE. PUMP RIGHT.

Water is one of the most valuable resources we have. It is high time we optimise our consumption. Especially in summer. The large quantities of water we need for our garden quite often come straight from the water mains. It is more environmentally friendly to use natural rain water or ground water, either from cisterns, wells or rainwater tanks.

Einhell water pumps help you use these natural sources in an efficient and sustainable manner. Whether it is a garden pump to water your plants or a domestic water supply system for the flushing toilets etc.: The Einhell pump advisor will find the right pump that meets your requirements.

### WHERE TECHNICAL EXPERTISE AND ENHANCED ENVIRONMENTAL PROTECTION MEET

Each of us is responsible for the environment in which we live. Even as individuals, we have an important role to play. Our contribution: expertise and technology for efficient resource utilization. ECO Power stands for the use of efficient technology.



For example, our ECO Pumps feature the latest advances in technology which appreciably improve the energy-to-performance output ratio.



#### PERFECT FLOW GEOMETRY

An optimised hydrodynamic flow duct reduces the flow resistance and 4100 l/h enables powerful, obstruction-free pumping of the water.



#### OPTIMISED IMPELLER

The optimised impeller with modified vane geometry ensures perfect flow characteristics. Powerful, fault-free operation, maximum flow rate and minimal electricity consumption are thus possible.



#### HIGH-GRADE MECHANICAL SEAL

We have designed high-grade mechanical seals into our ECO Power dirty water pumps to reduce friction and wear even in demanding conditions. The pumps last longer, reducing both resource consumption and the impact on the environment.



## SUBMERSIBLE PUMPS DIRTY/CLEAR WATER ECO



	<b>GE-DP 7935 N ECO</b> <b>EXPERT</b>	<b>GE-DP 3925 ECO</b> <b>EXPERT</b>
Suitable for	dirty water	dirty water
Mains voltage	230 V ~ 50 Hz	230 V ~ 50 Hz
Rated input	790 W	390 W
Max. delivery capacity / height	20000 l/h / 9 m	10000 l/h / 6 m
Max. immersion depth	7 m	7 m
Min. water level for pump start	50 mm	50 mm
Max. size of foreign particle	35 mm	25 mm
Hose connection	47.8 mm (1½") ET	47.8 mm (1½") ET
Power cord	10 m	10 m
Product weight	7.3 kg	4.5 kg
Integrated lifting eye	•	•
High-quality mechanical seal	•	•
Floating switch	Automatic + manual mode	Automatic + manual mode
Integrated cable rewind	•	•
ECO Power	•	•
Carry handle	•	•
Universal hose adapter	•	•
Article number	41.707.00	41.707.10

## DIRTY WATER PUMPS



	GC-DP 1340 G <b>CLASSIC</b>	GE-DP 900 Cut <b>EXPERT</b>	GC-DP 5010 G <b>CLASSIC</b>	GC-DP 9035 N <b>CLASSIC</b>
Mains voltage	230 V ~ 50 Hz	230 V ~ 50 Hz	220 - 240 V ~ 50 Hz	220 - 240 V ~ 50 Hz
Rated input	1300 W	900 W	500 W	900 W
Max. delivery capacity / height	23000 l/h / 10 m	16000 l/h / 11.5 m	12000 l/h / 8 m	18000 l/h / 9 m
Max. immersion depth	5 m	7 m	5 m	5 m
Max. size of foreign particle	40 mm	-	10 mm	35 mm
Hose connection	59.6 mm (2") IT	59.6 mm (2") IT	42 mm (1½") IT	47.8 mm (1½") IT
Power cord	10 m	10 m	10 m	10 m
Product weight	22.0 kg	17.0 kg	10.6 kg	6.0 kg
High-quality mechanical seal	•	•	•	•
Floating switch	Automatic mode	Automatic mode	Automatic mode	Automatic + manual mode
Integrated cable rewind	-	-	-	-
Carry handle	•	•	•	•
Cutting unit system	-	•	-	-
Universal hose adapter	•	•	•	•
Lowering rope	• (6 m)	-	-	-
Article number	41.707.42	41.815.50	41.714.21	41.707.78

## OUR COMPACT HELPERS.

Robust, powerful and extremely reliable helpers for pumping out construction pits, wells and other very dirty bodies of water.



## DIRTY WATER PUMPS



	<b>GC-DP 9040 N</b> <b>CLASSIC</b>
Mains voltage	230 V ~ 50 Hz
Rated input	900 W
Max. delivery capacity / height	22000 l/h / 9 m
Max. immersion depth	7 m
Max. size of foreign particle	40 mm
Hose connection	50 mm (2") IT
Power cord	10 m
Product weight	7.5 kg
High-quality mechanical seal	•
Floating switch	Automatic + manual mode
Integrated cable rewind	•
Carry handle	•
Cutting unit system	-
Universal hose adapter	•
Lowering rope	-
Article number	41.815.10

## DIRTY WATER PUMPS



	GC-DP 7835 <b>CLASSIC</b>	GC-DP 6315 N <b>CLASSIC</b>	GC-DP 3325 <b>CLASSIC</b>
Mains voltage	230 V ~ 50 Hz	230 V ~ 50 Hz	230 V ~ 50 Hz
Rated input	780 W	630 W	330 W
Max. delivery capacity / height	15700 l/h / 8 m	17000 l/h / 8 m	9500 l/h / 6 m
Max. immersion depth	7 m	5 m	5 m
Max. size of foreign particle	35 mm	15 mm	25 mm
Hose connection	47.8 mm (1½") IT	47.8 mm (1½") IT	47.8 mm (1½") IT
Power cord	10 m	10 m	10 m
Product weight	5.2 kg	4.7 kg	3.6 kg
High-quality mechanical seal	•	•	•
Floating switch	Automatic + manual mode	Automatic + manual mode	Automatic + manual mode
Integrated cable rewind	•	•	-
Carry handle	•	•	• (folding)
Cutting unit system	-	-	-
Universal hose adapter	•	•	•
Lowering rope	-	-	-
Article number	41.706.82	41.704.91	41.815.30

## THE PRACTICAL RAIN BARREL PUMP.

High-quality, reliable and efficient helper which was designed specially for drawing water from rain barrels and cisterns. An infinitely variable float switch can be used to set this robust pump to continuous operation or to a specific ON and OFF switching level. The pump has a flexible swan-neck with stopcock for individual positioning of the garden hose, as well as a rain barrel bracket for securing the pump to the barrel itself.



### RAIN BARREL PUMP



	<b>GE-SP 3546 RB</b> <b>EXPERT</b>
Mains voltage	230 V ~ 50 Hz
Rated input	350 W
Max. delivery capacity / height	4600 l/h / 11 m
Max. delivery capacity / height	7 m
Max. size of foreign particle	2.5 mm
Hose connection	26.4 mm (¾") ET
Power cord	10 m
Suction down to	-
Product weight	5.0 kg
High-quality mechanical seal	-
Floating switch	• (infinitely variable)
Integrated cable rewind	•
Carry handle	•
Flexible gooseneck	•
Storage compartment for extensions	•
Universal hose adapter	-
Article number	41.704.38



# FLEXIBILITY FOR CLEAR WATER APPLICATIONS.

Ideal for drainage, removal and transportation of clean and slightly soiled water.

## CLEAR WATER PUMPS



	<b>GC-SP 5511 IF</b> <b>CLASSIC</b>	<b>GC-SP 3580 LL</b> <b>CLASSIC</b>	<b>GC-SP 2275</b> <b>CLASSIC</b>
Mains voltage	230 V ~ 50 Hz	230 V ~ 50 Hz	230 V ~ 50 Hz
Rated input	550 W	350 W	220 W
Max. delivery capacity / height	11000 l/h / 8.5 m	8000 l/h / 7.5 m	7500 l/h / 6 m
Max. delivery capacity / height	7 m	7 m	5 m
Hose connection	47.8 mm (1½") IT	47.8 mm (1½") IT	47.8 mm (1½") IT
Power cord	10 m	10 m	10 m
Min. water level for pump start	60 mm	8 mm	-
Suction down to	5 mm	1 mm	8 mm
Product weight	4.4 kg	3.1 kg	3.4 kg
High-quality mechanical seal	-	•	•
Floating switch	Integrated (automatic + manual mode)	Automatic + manual mode	Automatic + manual mode
Integrated cable rewind	-	•	-
Carry handle	•	•	• (folding)
Universal hose adapter	•	•	•
Article number	41.704.63	41.704.45	41.815.20

## WATER POWER FOR HOUSE AND GARDEN.

If you need to pump water to particularly great heights or under very high pressure, then our submersible pressure pumps offer just the support you need.

The automatic function of the GE-PP 5555 RB-A represents an ideal and convenient solution, be it for watering gardens from a rain barrel via a practical extension pipe or for maintaining domestic water supplies.



## SUBMERSIBLE PRESSURE PUMPS



STAINLESS STEEL



	<b>GE-PP 1100 N-A</b> <b>EXPERT</b>	<b>GC-PP 900 N</b> <b>CLASSIC</b>	<b>GE-PP 5555 RB-A</b> <b>EXPERT</b>
Mains voltage	220 - 240 V ~ 50 Hz	230 V ~ 50 Hz	230 - 240 V ~ 50 Hz
Rated input	1100 W	900 W	550 W
Max. delivery capacity / height	6000 l/h / 45 m	6000 l/h / 32 m	5500 l/h / 20 m
Max. delivery capacity / height	12 m	7 m	7 m
Hose connection	33.3 mm (1") IT	33.3 mm (1") IT	33.3 mm (1") ET
Power cord	15 m	10 m	10 m
Product weight	8.7 kg	8.9 kg	5.0 kg
Automatic mode	•	-	•
Floating switch	-	•	-
Dry running protection	•	-	•
Multi-stage pump impeller	• (4 pcs)	• (3 pcs)	• (2 pcs)
High-quality mechanical seal	•	•	•
Overload cut-out	•	•	•
Integrated non-return valve	•	-	•
Stainless dirt screen	•	-	-
High-quality INOX steel pump housing	•	•	-
Integrated cable rewind	-	-	•
Carry handle	•	-	•
Telescopic extension tube	-	-	•
Flexible gooseneck	-	-	•
Article number	41.714.30	41.709.64	41.704.25

## WATER SUPPLY FROM DEEP RESERVOIRS.

Deep Well Pumps are extremely powerful and reliable devices for pumping water from deep reservoirs, wells or constricted pipes. They provide high pressure delivery for e.g. watering the garden and thanks to the automatic function, are also suitable for domestic water supplies. The sturdy pump housings are made of corrosion-resistant stainless steel.



## DEEP WELL PUMPS



	<b>GE-DW 1155 N-A</b> <b>EXPERT</b>	<b>GC-DW 1300 N</b> <b>CLASSIC</b>	<b>GC-DW 1045 N</b> <b>CLASSIC</b>
Mains voltage	220 - 240 V ~ 50 Hz	230 V ~ 50 Hz	220 - 240 V ~ 50 Hz
Rated input	1100 W	1300 W	1000 W
Max. delivery capacity / height	6000 l/h / 55 m	5000 l/h / 65 m	6500 l/h / 45 m
Max. immersion depth	19 m	20 m	19 m
Hose connection	33.3 mm (1") IT	47.8 mm (1½") IT	42 mm (1¼") IT
Power cord	22 m	2 m / 23 m	22 m
Pump diameter	98 mm	102 mm	98 mm
Product weight	9.8 kg	15.5 kg	7.7 kg
Automatic mode	•	-	-
Dry running protection	•	-	-
Multi-stage pump impeller	• (8 pcs)	• (10 pcs)	• (6 pcs)
High-quality mechanical seal	•	•	•
Overload cut-out	•	•	•
Integrated non-return valve	•	•	•
Stainless dirt screen	•	•	•
High-quality INOX steel pump housing	•	•	•
External switchbox	-	•	-
Lowering rope	• (22 m)	• (20 m)	• (22 m)
Article number	41.709.37	41.709.44	41.709.55



## **SURFACE PUMPS AT A GLANCE.**

No matter whether for watering tasks in the garden or for Domestic Water Supplies – Einhell surface pumps like garden pumps, automatic home and garden pumps, domestic water works or petrol water pumps are perfectly equipped for these challenges. Thanks to the high delivery pressure, high delivery heads or long delivery distances can be easily overcome.

With garden pumps or automatic home and garden pumps, groundwater can be pumped efficiently and safely for the environment from wells or cisterns and easily used to water the garden.

Fully automatic and with constant pressure with Einhell domestic water works and automatic home and garden pumps you can use collected service water in the home, for example to flush the toilet or in your washing machine.

And if no power supply is available, the range of cordless or petrol water pumps from Einhell is on hand to deliver pumping capability in any location.



1

### GARDEN PUMPS

For watering the garden.

NOW ALSO  
AVAILABLE AS  
**CORD-  
LESS**  
VERSIONS  
SEE PP. 17-19



2

### AUTOMATIC HOME AND GARDEN PUMPS

For automatic garden watering and domestic water supplies.



3

### WATER WORKS

For automatic domestic water supplies or garden watering.



4

### PETROL WATER PUMPS

For watering and drainage tasks - independently of the mains power supply.



## SURFACE PUMPS PLUS

### EASY PUMPING WITH THE NEW SURFACE PUMP GENERATION FROM EINHELL.

Fast and easy installation as well as quick error detection thanks to **status indicators**.

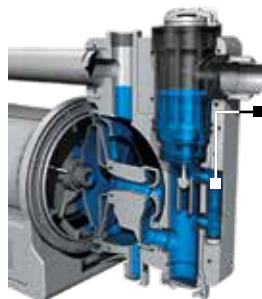

EXPERT Version

#### WATER FILLING INDICATOR

Before starting-up the pump for the first time it needs to be filled with water to secure a flawless intake procedure. Thanks to the sight glass the customer can see at first sight if there is already enough water filled into the pump.



CLASSIC Version



#### SUCTION INDICATOR

A pressure gauge in the cover of the water filling opening continuously shows the current suction pressure and the suction height.

#### BIG WATER FILLER OPENING

Big water filler opening through which it is very easy to fill water into the pump.

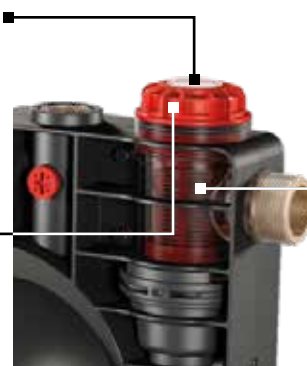

#### DIRT INDICATOR

Thanks to the transparent housing surrounding the coarse filter, it is easy to see whether the filter is dirty and may need cleaning.



#### PRE-FILTER

Integrated filter incl. non-return valve – easy to take out for cleaning or replacement.

## SURFACE PUMP PLUS

Long life, low maintenance and exceptional **protection** thanks to special **safety mechanisms**.

### SCALDING PROTECTION

As part of the dry-run safeguard system, the scalding protection function prevents the water remaining in the pump's body from getting hot. If the pump outlet (on the delivery side) should close or become partly blocked for whatever reason and the pump continue to work, the water would gradually become hotter and hotter. The scalding protection function prevents this and switches off the pump in good time.

### FROST PROTECTION – WATER DRAIN SCREW

To protect the pump from expansion of the water at below-freezing temperatures the pump can be easily emptied with a water drain screw.

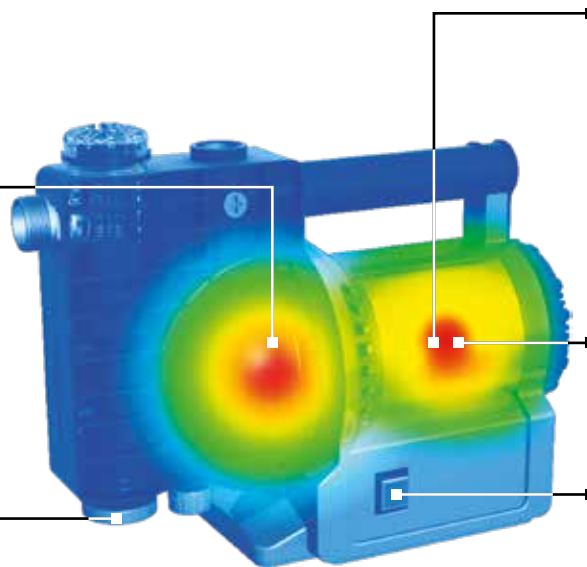

### DRY RUNNING PROTECTION

If the pump is no longer able to draw in any water (e.g. the water source is empty), the dry running protection function will recognize this and will stop the pump after approx. 30 seconds in idle mode. If there is still no water being drawn in when it tries to restart the pump, it will stop again within another 30 seconds and shut off the pump. This prevents overheating of not only the pump but also the motor.

### THERMO PROTECTION

To prevent severe damage, the integrated thermo switch cuts off the pump when the motor overheats.

### WATER FLOW RECOGNITION SENSOR

A sensor indicates (by LEDs or an LCD display, depending on the model) if there is proper water flow:



- Red: Failure – no water in the pump
- Yellow: Flow detection
- Green: Pump runs normal

## GARDEN PUMPS PLUS

Einhell Garden Pumps Plus have innovative features to make them even more user-friendly than previous garden pumps.

Starting up and troubleshooting are even easier than ever before thanks to innovative status indicators such as suction, dirt and water filling indicators. For a long service life, low maintenance and exceptional protection, some models have special safety mechanisms such as the flow sensor, dry running protection, scalding protection and frost protection. But every model has a thermo switch for protection against damage caused by overheating of the motor.

## GARDEN PUMPS PLUS



	<b>GE-GP 1246 N FS</b> <b>EXPERT</b>	<b>GE-GP 1145 ECO</b> <b>EXPERT</b>
Mains voltage	220 - 240 V ~ 50 Hz	220 - 240 V ~ 50 Hz
Rated input	1200 W	1100 W
Max. delivery capacity / height	4600 l/h / 50 m	4500 l/h / 48 m
Max. suction height	8 m	8 m
Suction connection	42 mm (1¼") ET	42 mm (1¼") ET
Pressure connection	33.3 mm (1") IT	33.3 mm (1") IT
Additional pressure side connection	33.3 mm (1") IT	33.3 mm (1") IT
Power cord	1.5 m	1.5 m
Product weight	14.0 kg	14.0 kg
Water filler screw	•	•
Water filling / dirt / suction indicators	• / • / •	• / • / •
Integrated pre-filter with non-return valve	•	•
Carry handle	Comfort	Comfort
Frost protection due to a water drain screw	•	•
Thermo protection	•	•
Water flow recognition sensor / dry running protection / scalding protection	• / • / •	- / - / -
ECO Power	-	•
Incl. adapter 33.3 mm (1") ET	•	•
Article number	41.803.60	41.803.70



## GARDEN PUMPS PLUS



	<b>GC-GP 1250 N/1</b> <b>CLASSIC</b>	<b>GC-GP 1045</b> <b>CLASSIC</b>	<b>GC-GP 6040 ECO</b> <b>CLASSIC</b>
Mains voltage	220 - 240 V ~ 50 Hz	220 - 240 V ~ 50 Hz	220 - 240 V ~ 50 Hz
Rated input	1200 W	1050 W	600 W
Max. delivery capacity / height	5000 l/h / 50 m	4500 l/h / 48 m	4000 l/h / 36 m
Max. suction height	8 m	8 m	8 m
Suction connection	42 mm (1¼") ET	42 mm (1¼") ET	42 mm (1¼") ET
Pressure connection	33.3 mm (1") IT	33.3 mm (1") IT	33.3 mm (1") IT
Additional pressure side connection	-	-	-
Power cord	1.5 m	1.5 m	1.5 m
Product weight	9.7 kg	9.5 kg	6.1 kg
Water filler screw	•	•	•
Water filling / dirt / suction indicators	• / - / -	• / - / -	• / - / -
Integrated pre-filter with non-return valve	-	-	-
Carry handle	Comfort	Comfort	foldable
Frost protection due to a water drain screw	•	•	•
Thermo protection	•	•	•
ECO Power	-	-	•
Incl. adapter 33.3 mm (1") ET	•	•	•
Article number	41.803.50	41.803.40	41.803.20

## GARDEN PUMPS



	<b>GC-GP 6538</b> <b>CLASSIC</b>	<b>GC-GP 6538 Set</b> <b>CLASSIC</b>	<b>GC-GP 6538 Set/I</b> <b>CLASSIC</b>
Mains voltage	220 - 240 V ~ 50 Hz	220 - 240 V ~ 50 Hz	220 - 240 V ~ 50 Hz
Rated input	650 W	650 W	650 W
Max. delivery capacity / height	3800 l/h / 36 m	3800 l/h / 36 m	3800 l/h / 36 m
Max. suction height	8 m	8 m	8 m
Suction connection	33.3 mm (1") ET	33.3 mm (1") ET	33.3 mm (1") ET
Pressure connection	33.3 mm (1") ET	33.3 mm (1") ET	33.3 mm (1") ET
Power cord	1.4 m	1.4 m	1.4 m
Product weight	6.1 kg	6.1 kg	6.1 kg
Water filler screw	•	•	•
Water drain screw	•	•	•
High-quality mechanical seal	•	•	•
Carry handle	•	•	•
Suction hose included	-	• (7 m)	• (4 m)
Article number	41.802.80	41.802.83	41.802.86

## GARDEN PUMPS



	<b>GC-GP 6036</b> <b>CLASSIC</b>	<b>GC-TP 4622</b> <b>CLASSIC</b>
Mains voltage	230 V ~ 50 Hz	220 - 240 V ~ 50 Hz
Rated input	600 W	460 W
Max. delivery capacity / height	3600 l/h / 40 m	2250 l/h / 37 m
Max. suction height	8 m	-
Suction connection	33.3 mm (1") IT	33.3 mm (1") IT
Pressure connection	33.3 mm (1") IT	33.3 mm (1") IT
Power cord	1.5 m	1.5 m
Product weight	9.5 kg	6.1 kg
Water filler screw	•	•
Water drain screw	•	•
High-quality mechanical seal	-	-
Carry handle	•	-
Suction hose included	-	-
Article number	41.802.69	41.834.00

ALL-ROUNDERS  
FOR THE GARDEN.

Einhell Garden Pumps are useful aids for watering the garden. Water from ponds, water butts or wells are ideally suited to watering lawns or plants, avoiding the use of valuable drinking water resources in the process. Just like all of our other surface pumps, the garden pumps are placed outside the water, which they suck in via a suction hose and pump through a pressure hose/delivery hose to the consumers.

## INNOVATIVE TECHNOLOGY. INTELLIGENT NETWORKING.

The Einhell Automatic Home and Garden Pump GE-AW 1144 SMART makes watering possible from anywhere. Via the Einhell Connect app, manual control, scheduled or smart watering is carried out with the help of weather data.

Using an app it is also possible to network and coordinate Einhell's SMART devices with each other in order, for example, to specify a sequence which would lead to the garden pump being switched on automatically to water the lawn after it has been cut by the robot lawn mower.



## AUTOMATIC HOME AND GARDEN PUMP SMART



### GE-AW 1144 SMART

**EXPERT**

**NEW**

Mains voltage	220 - 240 V ~ 50 Hz
Rated input	1100 W
Max. delivery capacity / height	4400 l/h / 48 m
Max. pressure	4.8 bar
Max. suction height	8 m
Suction connection	42 mm (1¼") ET
Pressure connection	33.3 mm (1") IT
Power cord	1.5 m
Product weight	11.4 kg
Smart connectivity	<ul style="list-style-type: none"> <li>• GSM, NB-IOT</li> </ul>
App control	•
Schedule Mode	<ul style="list-style-type: none"> <li>• (minute-by-minute)</li> </ul>
Operation time calculation based on current weather data	•
Networkable with all Einhell SMART devices	•
Automatic mode	•
Dry running protection	•
Indicator	LED
Water filler screw	•
Water drain screw	•
Pre-filter + non-return valve	•
Thermo protection	•
Article number	41.803.80



### CAN BE CONTROLLED FROM EVERYWHERE

Thanks to mobile internet connectivity, a smart-phone now lets you do your watering tasks from wherever you might be



### SMART MODUS

In Smart Mode the pump automatically draws up a work schedule that is optimally coordinated with the weather and the customer's preferences



### NETWORKABLE WITH EINHELL SMART TOOLS

Einhell Smart Tools work together automatically in Smart Mode



### NO WIFI OR BLUETOOTH NEEDED

Annoying restrictions due to Bluetooth or WiFi ranges are a thing of the past. Communication via mobile phone network (no additional costs!)

\* Preconditions: mobile phone network available; within European Union



### WEATHER DATA TAKEN INTO ACCOUNT

In Smart Mode the tool calls up the real-time weather data for the actual location and adapts the watering times accordingly



### SCHEDULE MODE

The pump starts its work window in accordance with the defined time window

Another SMART tool from the Einhell range:  
**Power X-Change  
 Robot Lawn Mower  
 FREELEXO SMART 750**



## AUTOMATIC HOME AND GARDEN PUMPS PLUS

Einhell Automatic Home and Garden Pumps PLUS have innovative features to make them even more user-friendly than previous automatic home and garden pumps.

Starting up and troubleshooting are even easier than ever before thanks to innovative status indicators such as suction, dirt and water filling indicators. For a long service life, low maintenance and exceptional protection, special safety mechanisms such as the flow sensor, dry running protection, scalding protection and frost protection are included. Like every Einhell pump, they have thermo protection to prevent any damage from overheating of the motor.



## AUTOMATIC HOME AND GARDEN PUMPS PLUS



	<b>GE-AW 1246 N FS</b> <b>EXPERT</b>	<b>GE-AW 1042 FS</b> <b>EXPERT</b>
Mains voltage	220 - 240 V ~ 50 Hz	220 - 240 V ~ 50 Hz
Rated input	1200 W	1050 W
Max. delivery capacity / height	4600 l/h / 50 m	4200 l/h / 48 m
Max. pressure	5.0 bar	4.8 bar
Max. suction height	8 m	8 m
Suction connection	42 mm (1½") ET	42 mm (1½") ET
Pressure connection	33.3 mm (1") IT	33.3 mm (1") IT
Additional pressure side connection	33.3 mm (1") IT	33.3 mm (1") IT
Power cord	1.5 m	1.5 m
Product weight	15.0 kg	15.0 kg
Automatic mode	•	•
Timer function	•	-
Water filler screw	•	•
Water filling / dirt / suction indicators	• / • / •	• / • / •
Integrated pre-filter with non-return valve	•	•
Carry handle	Comfort	Comfort
Frost protection due to a water drain screw	•	•
Thermo protection	•	•
Water flow recognition sensor / dry running protection / scalding protection	• / • / •	• / • / •
Incl. adapter 33.3 mm (1") ET	•	•
Article number	41.770.20	41.770.10

## AUTOMATIC HOME AND GARDEN PUMP



	<b>GC-AW 6333</b> <b>CLASSIC</b>
Mains voltage	230 V ~ 50 Hz
Rated input	630 W
Max. delivery capacity / height	3300 l/h / 36 m
Max. pressure	3.6 bar
Max. suction height	8 m
Suction connection	42 mm (1½") ET
Pressure connection	33.3 mm (1") IT
Power cord	1.5 m
Product weight	7.8 kg
Automatic mode	•
Timer function	-
Dry running protection	•
Indicator	LED
Water filler screw	•
Water drain screw	•
ECO Power	-
Pre-filter with integrated non-return valve	•
Carry handle	•
Article number	41.767.30

## THE COMPLETE SUPPLY PACKAGE – FOR THE HOUSE AND THE GARDEN.

Einhell Automatic Home and Garden Pumps are perfect for house and garden: Whether for automatic domestic water supplies to provide service water for toilet flushing or washing machines or for automatic garden watering – this is no problem at all.

But what is the difference to a standard garden pump? An integrated flow switch automatically switches the pump on when a water demand is present and then off again, allowing this type of pump to be used fully automatically for domestic water supplies or for garden watering tasks, reducing the demand for valuable drinking water resources in the process.





## WATER WORKS PLUS

Starting up and troubleshooting are even easier than ever before thanks to innovative status indicators such as suction, dirt and water filling indicators. For a long service life, low maintenance and exceptional protection, some models have special safety mechanisms such as the flow sensor, dry running protection, scalding protection and frost protection. But every model has a thermo switch for protection against damage caused by overheating of the motor.



## WATER WORKS PLUS

**20 l  
TANK**

	<b>GE-WW 1246 N FS</b> <b>EXPERT</b>	<b>GE-WW 1145 ECO</b> <b>EXPERT</b>	<b>GC-WW 1045 N</b> <b>CLASSIC</b>
Mains voltage	220 - 240 V ~ 50 Hz	220 - 240 V ~ 50 Hz	220 - 240 V ~ 50 Hz
Rated input	1200 W	1100 W	1050 W
Max. delivery capacity / height	4600 l/h / 50 m	4500 l/h / 48 m	4500 l/h / 48 m
Max. suction height	8 m	8 m	8 m
Suction connection	42 mm (1¼") ET	42 mm (1¼") ET	42 mm (1¼") ET
Pressure connection	33.3 mm (1") IT	33.3 mm (1") IT	33.3 mm (1") IT
Additional pressure side connection	33.3 mm (1") IT	33.3 mm (1") IT	-
Tank volume	20 l	20 l	20 l
Max. activation / cut off pressure	1.5 bar / 3 bar	1.5 bar / 3 bar	1.5 bar / 3 bar
Power cord	1.5 m	1.5 m	1.5 m
Product weight	19.5 kg	19.5 kg	17.3 kg
Water filler screw	•	•	•
Water filling / dirt / suction indicators	• / • / •	• / • / •	• / - / -
Integrated pre-filter with non-return valve	•	•	-
Carry handle	Comfort	Comfort	Comfort
Frost protection due to a water drain screw	•	•	•
Thermo protection	•	•	•
Water flow recognition sensor / dry running protection / scalding protection	• / • / •	- / - / -	- / - / -
Incl. adapter 33.3 mm (1") ET	•	•	•
Article number	41.735.30	41.735.40	41.735.20

## DOMESTIC WATER WORKS SUPPLIES MADE EASY.

Einhell Domestic Water Works are not only quiet and environmentally friendly, but they also represent a cost-effective alternative to domestic water supplies with drinking water. They enable clean water to be delivered from reservoirs, wells and shafts for use as service water in irrigation systems, washing equipment, toilet flushing systems and much more besides. The pressure vessel offers a capacity of 20 litres, so the pump does not need to start up every time water is drawn off.

An integrated pressure switch will activate the pump when the pressure drops and deactivate it again when the pressure returns to maximum. On the integrated pressure gauge you can read off the pressure at a glance.

## WATER WORKS



	<b>GC-WW 1250 NN CLASSIC</b>
Mains voltage	220 - 240 V - 50 Hz
Rated input	1200 W
Max. delivery capacity / height	5000 l/h / 50 m
Max. suction height	8 m
Tank volume	20 l
Max. activation / cut off pressure	1.5 bar / 3 bar
Suction connection	42 mm (1½") ET
Pressure connection	33.3 mm (1") IT
Power cord	1.5 m
Product weight	14.7 kg
Overload protection	•
Water filler screw	•
Water drain screw	•
High-quality mechanical seal	•
INOX stainless steel pressure tank	•
Pre-filter with integrated non-return valve	-
Pressure gauge	•
Suction hose included	-
Article number	41.734.90

## WATER WORKS



**20 l  
TANK**



	<b>GC-WW 6538</b> <b>CLASSIC</b>	<b>GC-WW 6538 Set</b> <b>CLASSIC</b>	<b>GC-WW 6036</b> <b>CLASSIC</b>
Mains voltage	220 - 240 V ~ 50 Hz	220 - 240 V ~ 50 Hz	230 V ~ 50 Hz
Rated input	650 W	650 W	600 W
Max. delivery capacity / height	3800 l/h / 36 m	3800 l/h / 36 m	3600 l/h / 40 m
Max. suction height	8 m	8 m	8 m
Tank volume	20 l	20 l	20 l
Max. activation / cut off pressure	1.5 bar / 3 bar	1.5 bar / 3 bar	1.5 bar / 3 bar
Suction connection	33.3 mm (1") ET	33.3 mm (1") ET	33.3 mm (1") IT
Pressure connection	33.3 mm (1") ET	33.3 mm (1") ET	33.3 mm (1") IT
Power cord	1.4 m	1.4 m	1.5 m
Product weight	10.5 kg	10.5 kg	14.3 kg
Overload protection	•	•	•
Water filler screw	•	•	•
Water drain screw	•	•	-
High-quality mechanical seal	•	•	-
Pressure gauge	•	•	•
Suction hose included	-	7 m	-
Article number	41.731.90	41.731.93	41.731.18

## FULL POWER – WITHOUT ANY ELECTRICITY AT ALL.

With Einhell Petrol Water Pumps, you are always independent of a mains power supply – whether on a camping trip or working in your allotment. The petrol-powered water pumps are suitable not only for harsh, high-performance applications for mains supply-independent water supply tasks, but also for numerous permanent drainage tasks. Thanks to the low-consumption pump technology, these pumps are ideally suited to numerous permanent drainage and watering tasks.

### PETROL WATER PUMPS



	<b>GE-PW 46</b> <b>EXPERT</b>	<b>GC-PW 16</b> <b>CLASSIC</b>
Engine	four-stroke	four-stroke
Power rating	4.6 / 6.3	1.6 / 2.2
Max. delivery capacity / height	23000 l/h / 26 m	14000 l/h / 28 m
Max. suction height	6.5 m	7.0 m
Max. speed	3600 min <sup>-1</sup>	3600 min <sup>-1</sup>
Suction connection	59.6 mm (2") ET	47.8 mm (1½") ET
Pressure connection	59.6 mm (2") ET	47.8 mm (1½") ET
Fuel tank capacity	3.6 l	1.8 l
Product weight	21.8 kg	15.5 kg
Non-return valve	•	•
Sturdy steel tube frame	•	–
Water filler port	•	•
Water drain screw	•	•
Oil filling screw	•	•
Low oil stop	•	•
Incl. hose adapter	2x 50.8 mm (2")	2x 38.1 mm (1.5")
Incl. intake cage	• (2")	• (1.5")
Incl. reducer section	2x 47.8 mm (1.5") ET, 2x 33.3 mm (1") ET	–
Article number	41.713.72	41.905.30

## SURFACE PUMPS ACCESSORIES



	Suction Hose	Suction Hose	Suction Hose	Suction Hose
Length	4 m	4 m	7 m	7 m
Connectors material	brass	plastic	brass	plastic
Connectors	42 mm (1¼") IT	42 mm (1¼") IT	42 mm (1¼") IT	42 mm (1¼") IT
Hose diameter	25 mm (1")	25 mm (1")	25 mm (1")	25 mm (1")
Threaded nipple	33.3 mm (1") ET	33.3 mm (1") ET	33.3 mm (1") ET	33.3 mm (1") ET
Adapter	33.3 mm (1") IT	33.3 mm (1") IT	33.3 mm (1") IT	33.3 mm (1") IT
Article number	41.736.30	41.736.35	41.736.40	41.736.45

## SURFACE PUMPS ACCESSORIES



	Coarse Filter 12 cm	Coarse Filter 25 cm
Height of filter insert	12 cm	25 cm
Brass connection	33.3 mm (1") IT	33.3 mm (1") IT
Max. operation pressure	5.5 bar	5.5 bar
Max. delivery quantity	4000 l/h	4000 l/h
Connector	33.3 mm (1") ET / 42 mm (1 1/4") IT	33.3 mm (1") ET / 42 mm (1 1/4") IT
Double Nipple	33.3 mm (1") ET	33.3 mm (1") ET
Cartridge included	•	•
Article number	41.738.01	41.738.51

## SURFACE PUMPS ACCESSORIES



	Electronic Flow Switch <span style="color: red; font-weight: bold;">NEW</span>
Max. operation pressure	11 bar
Max. water temperature	55°C
Non-return valve	•
Integrated dry running protection	•
Article number	41.742.30





# PUMPING MADE EASY. WATER TECHNOLOGY FOR HOUSE AND GARDEN.

## Einhell Germany AG

Wiesenweg 22  
94405 Landau/Isar  
Germany

info@einhell.de  
www.einhell.de

## Einhell-Service

Eschenstr. 6  
94405 Landau/Isar  
Germany

Tel. +49 (0) 9951 959 2000

Service-DE@einhell.com  
www.einhell-service.com



einhell.de  
>>>